

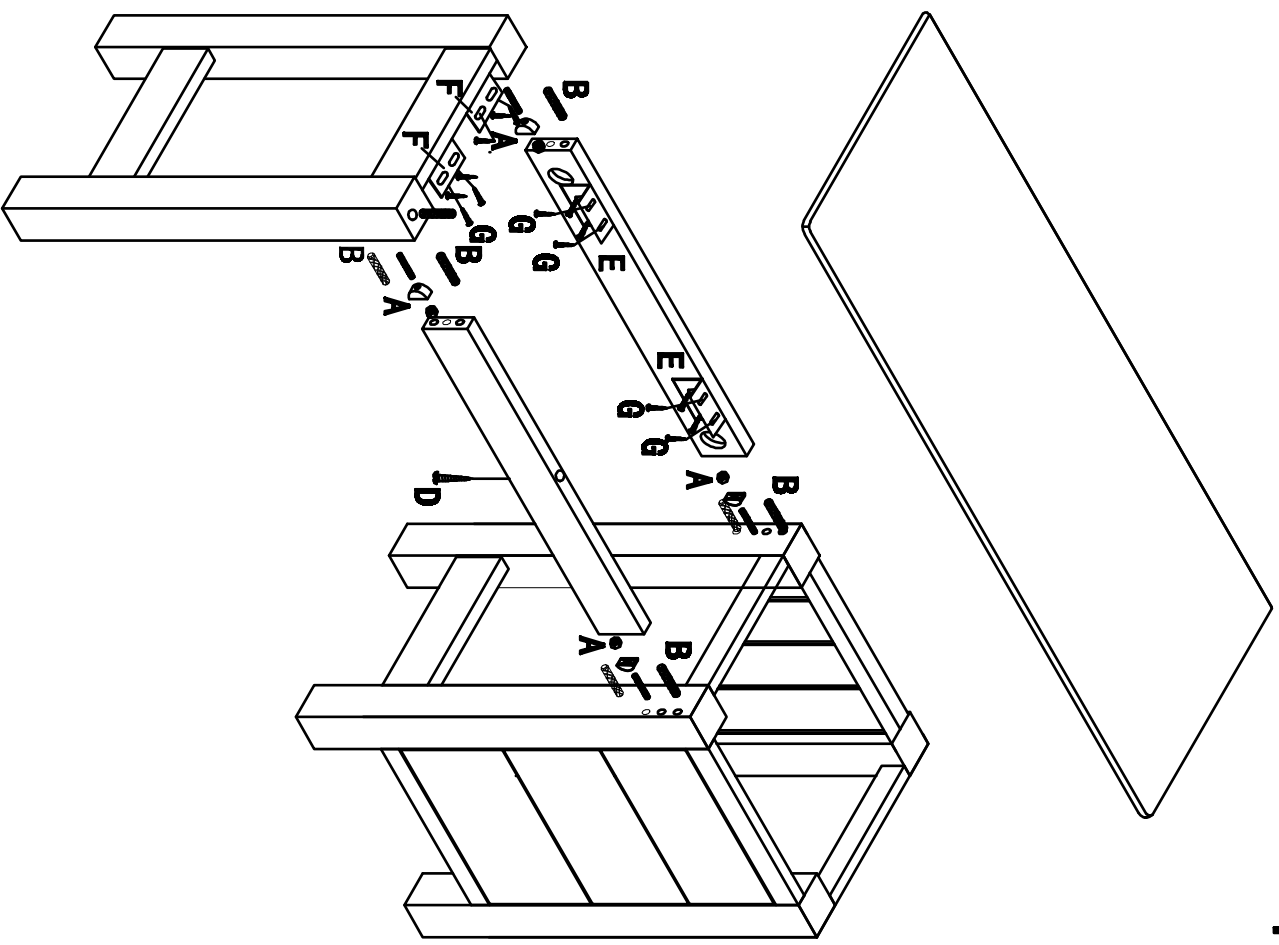

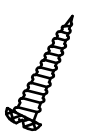

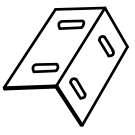

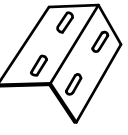

TO-SINGLE PED DRESSING TABLE



	$\phi 4 \times 16$				
	EX2		AX4		$\phi 10 \times 40$
	FX2		$\phi 4 \times 35$	BX9	DX1